

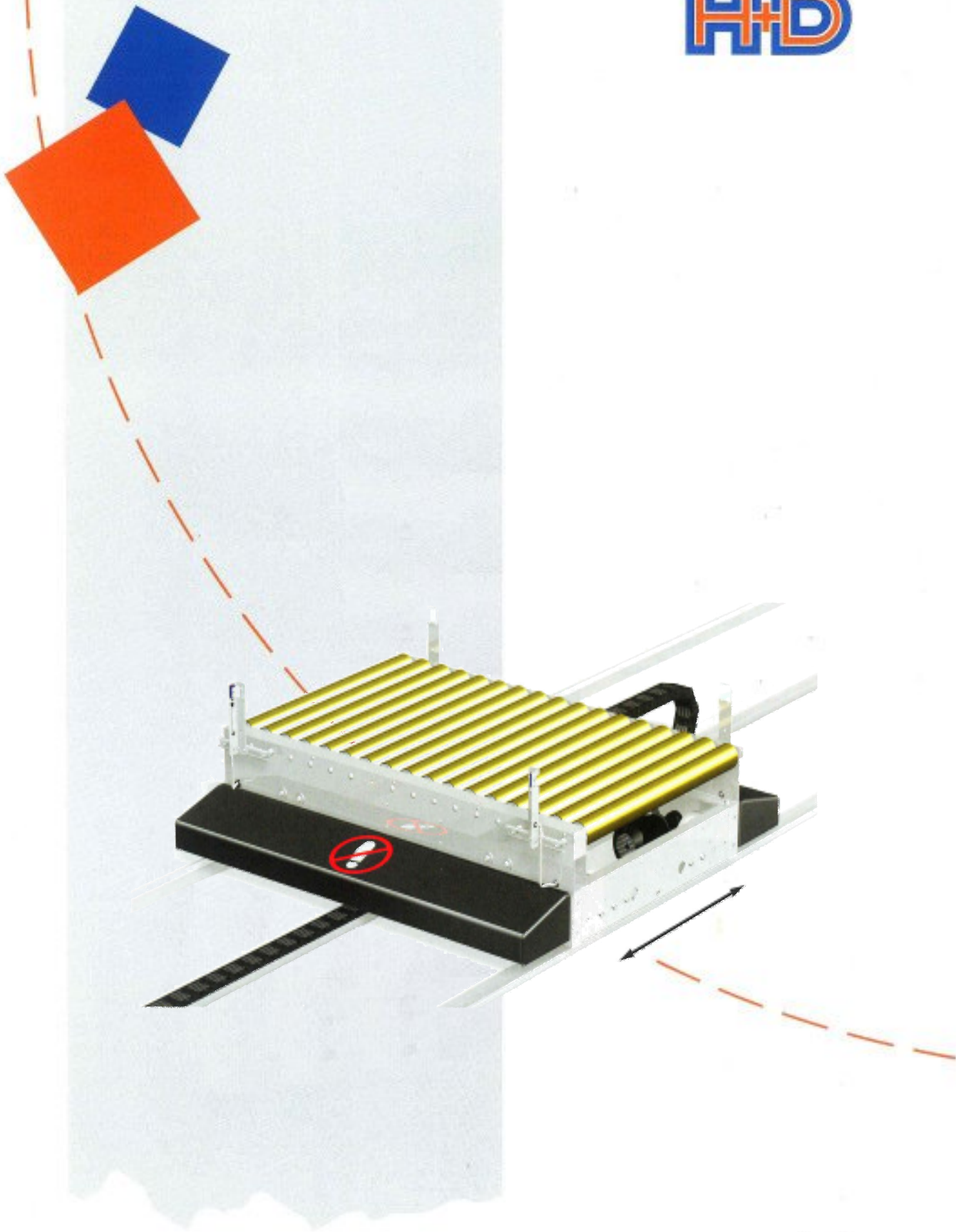

VERPACKEN MIT SYSTEM



Palettenfördertechnik **5.1**

# Komplettprogramm

1

**Kartonaufrichten**  
vollautomatisch  
halbautomatisch  
manuell



2

**Kartonverschluß mit Klebeband**  
vollautomatisch  
halbautomatisch  
manuell



3

**Kartonverschluß mit Umreifungsband**  
vollautomatisch  
halbautomatisch  
manuell



4

**Fördersysteme**  
Rollbahnen freilaufend  
und angetrieben  
Bandförderer  
Zusatzeinrichtungen



5

**Palettieren**  
vollautomatisch  
halbautomatisch

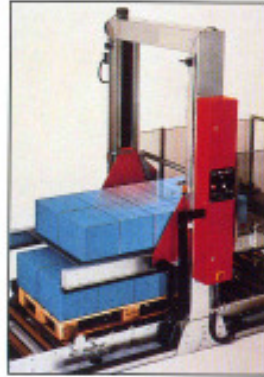

6

**Palettensicherung und Ladungssicherung**  
vollautomatisch  
halbautomatisch  
manuell

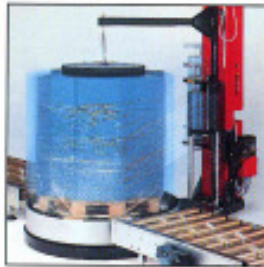

7

**Handlingsysteme**  
Saugheber  
Palettenmagazine  
Vertikalförderer  
Roboter



8

**Packmittel und Packraumeinrichtung**  
Kleben  
Umreifen  
Verschnüren  
Heften  
Packplatzgestaltung



## Which pallet types do you use?

Pallet size, configuration, construction, and weight decide the conveyor type.



**Standard EUR pallets 800 mm x 1200 mm, 1000 mm x 1200 mm and 1200 mm x 1200 mm can be moved longways** i.e. with the 800 mm, 1000 mm or 1200 mm side leading – on standard pallet roller conveyors with roller pitch 178 mm.

**can be moved crossways** i.e. with the 1200 mm side leading – on pallet roller conveyors with narrow roller pitch, i.e. pitch 89 mm.



**400 mm x 600 mm pallets – so-called 1/4 pallets, and 600 mm x 800 mm pallets – so-called 1/2 pallets** can usually be moved on pallet conveyors with narrow roller pitch 89 mm, however there are bottom configurations that do not allow this – please consult SOCO SYSTEM for advice and further details.



**48" x 42" and 48" x 48" – GMA type pallets** can, in most cases, be moved with 48" side leading on conveyors with roller pitch 178 mm and with either side leading on conveyors with narrow roller pitch, i.e. 89 mm.



### Full base pallets

i.e. pallets with bottom boards in all 4 directions can easily be moved with either side leading on conveyors with roller pitch 178 mm.



## Chain or roller conveyor?

Chain conveyors are used where the bottom configuration of the pallets does not allow it to be moved on pallet roller conveyors.

Chain conveyors are often more suitable for 1/4 pallets.

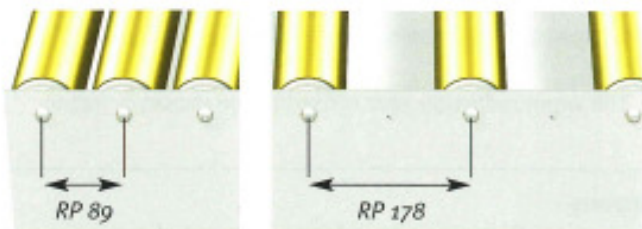

## Which roller pitch to use?

Roller pitch – RP – is the distance between the roller centres.

RP 178 mm with roller diameter 80 mm is the most economical in terms of conveyor price, however, in certain cases, this requires guard or fence to meet industry requirements and regulations for personnel safety and security.

RP 89 mm allows most pallet configurations to be conveyed with either side leading.



## Driven or non driven?

SOCO SYSTEM does not recommend handling of loaded pallets on non-driven conveyors. The reason is that loads can easily become dislocated on the pallets, products can slide and fall off the pallets, causing product damage and personnel hazards.

# The pallet handling system

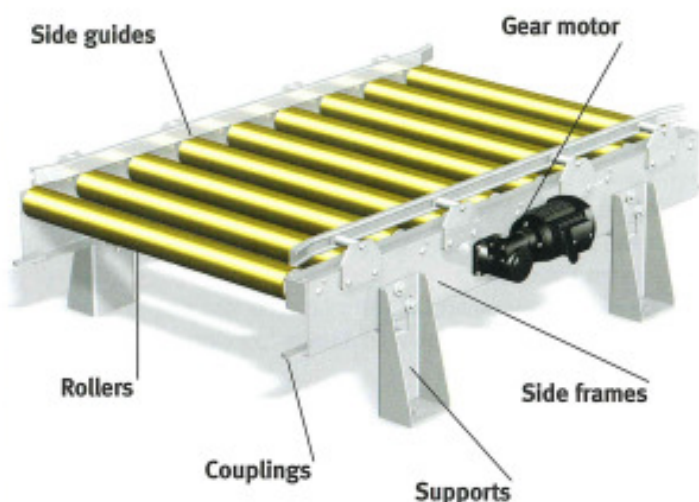

## A world of possibilities

Imagination is the only limitation to the number of possible applications of the pallet handling system.

To give an idea of the construction principles and the possibilities, the various components of a driven roller pallet conveyor are explained.

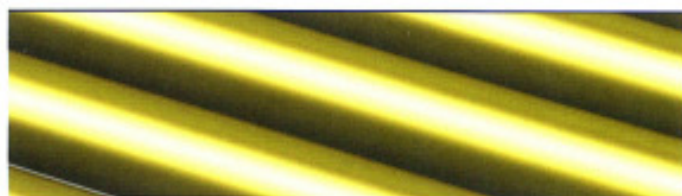

### Rollers

SOCO SYSTEM's rollers and chains have excellent wear and tear properties, and they are smooth-running components made from the best raw materials. Standard diameter is  $\varnothing$  80 mm.



### Side guides

Side guides are available for mounting in different heights. The side guides aid the pallets to maintain the correct direction.



### Side frames

The frames form the main structure of the conveyor and are designed for both function and harmony.

Frames come in different heights: 90 mm for mounting direct on the floor and 190 mm for additional heights.



### Gear motor

The sturdy and reliable standard gear motor is a 0.37 kW motor with a speed of 11.4 m/min. Other speeds are available on request.

The worm reduction gear is fixed to the conveyor frame.



### Supports

Are available for inside or outside mounting, for stationary attachment to floor, or to stand direct on the floor.

Supports are available in various heights.



### Couplings

Standard fittings makes it easy to connect themodules.

All couplings are easily and quickly mounted.

## Pallet roller conveyors

To be used where height needs to be low, for direct floor mounting, or integration with machines and other equipment

Height  
**90**

- Driven pallet roller conveyors** ..... page 8
- Coupled sections** ..... page 8
- Non-driven pallet roller conveyors** ..... page 9
- Driven 2- parted pallet roller conveyors** ..... page 9  
To be used where hand lift truck is required
- Non-driven 2-parted pallet roller conveyors** ... page 9



## Pallet roller conveyors

For mounting with or without supports

Height  
**190**

- Driven pallet roller conveyors** ..... page 10  
Available with side- or submounted motor
- Coupled sections** ..... page 11
- Non-driven pallet roller conveyors** ..... page 11



## Accessories for pallet roller conveyors

**Supports – external – for heavy-duty use**

**Supports – internal**

**Pallet guides – side and centre**

**Pallet end stop**

**Sensor plate**

**Guiding wheel**

**Pneumatic pallet stop**

**Brake roller**

**Photocell fixtures**

**Fork lift guard**

**Fork lift stop**

**Support rollers** ..... pages 12-15





## Chain conveyors

For mounting with or without supports

Driven conveyors simplex (single chain) ..... page 16

Driven conveyors duplex (double chain) ..... page 17

Driven conveyors double (simplex chain) ..... page 17



## Accessories for chain conveyors

Supports

Side guides – external

Pallet end stop

Capacitive sensors

Photocell fixtures

Fork lift stop

Pneumatic pallet stop

Supporting block

Top cover plates ..... pages 18-21

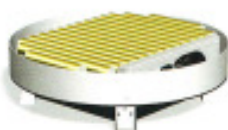

## Pallet rotary tables

Available with roller conveyor or chain conveyor

Rotary tables ..... pages 22-23



## Pallet transfer units

Transfer the pallet across a conveyor

Transfer units ..... page 23



## Pallet transfer trolleys

Transfer the pallet to another location

Transfer trolleys ..... page 24



## Pallet exchangers

For easy exchange of pallets at the packing station  
or stacking of pallets

Pallet exchangers ..... page 25

**Pallet magazines**

Stacking and destacking of pallets

PalManager – a versatile pallet magazine..... pages 26-27

Pallet magazine for heavy-duty use..... page 27



**Control systems**

Control systems for end-of-line systems ..... page 28



**Safety and protection**

CE requirements and fencing ..... page 29



**General specifications**

SOCO SYSTEM standard products..... page 30



**Overall dimensions of modules**

Overall widths, heights and lengths ..... page 31

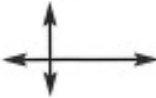

*Pallet conveyor system for handling of pallet containers with liquids at Coloplast in Denmark.*

# Pallet roller conveyors – height 90



## Driven pallet roller conveyors

For floor mounting.

The max. length of a roller conveyor with one gear motor is 4.5 m with a max. payload of 1500 kg. All sections are supplied with coupling fittings.

Accessories pages 12-15.

### Specifications

**Frames:** Cold-bend angle profiles bolted to C-profile cross bars with supports.

**Surface treatment:** Electro galvanized steel with the exception of gear motor, chain, and roller axles. Rollers are electro galvanized with yellow cromating.

**Rollers:** Ø 80 mm electro galvanized steel tubes.

**Axle diameter:** Ø 17 mm.

**Bearings:** 6203 – 2RS.

**Roller fittings:** Rollers suspended between side frames by means of M10 axle.

**Payload:** Max. 1500 kg per conveyor and per gear motor.

**Standard heights:** The total height from floor to top of rollers is 90 mm. For heights 190 mm and higher, see pages 10 and 11.

**Chain drive for rollers:** Chains operate beneath roller surface. Chain drive is from roller to roller. ½" sprockets of hardened steel are integrated with the bearing of the roller.

## Driven pallet conveyors

HEIGHT 90 MM. SIDE MOUNTED MOTOR

WIDTH	LENGTH	Rp 89 ITEM NO.	Rp 178 ITEM NO.
970	500	485911131	n.a.
	750	485911231	n.a.
	1000	480711131	480721131
	1500	480711231	480721231
	2000	480711331	480721331
1170	500	485912131	n.a.
	750	485912231	n.a.
	1000	480712131	480722131
	1500	480712231	480722231
	2000	480712331	480722331
1370	500	485913131	n.a.
	750	485913231	n.a.
	1000	480713131	480723131
	1500	480713231	480723231
	2000	480713331	480723331

All measurements are in mm.

n.a.: not available.

**Chain cover:** Chains are protected by a u-profile mounted above the chains. The chain cover is beneath roller height to ensure access to pallets from both sides of the conveyor.

**Gear motor:** 0.37 kW. Worm reduction gear sidemounted on conveyor frame.

**Speed:** 11.4 m/min (other speeds available).



## Coupled sections for driven pallet roller conveyors

For floor mounting.

Same specifications as for driven conveyors but without gear motor.

## Coupled sections for driven pallet conveyors

HEIGHT 90 MM

WIDTH	LENGTH	Rp 89 ITEM NO.	Rp 178 ITEM NO.
970	250	485911030	n.a.
	500	485911130	n.a.
	750	485911230	n.a.
	1000	480711130	480721130
	1500	480711230	480721230
	2000	480711330	480721330
1170	250	485912030	n.a.
	500	485912130	n.a.
	750	485912230	n.a.
	1000	480712130	480722130
	1500	480712230	480722230
	2000	480712330	480722330
1370	250	485913030	n.a.
	500	485913130	n.a.
	750	485913230	n.a.
	1000	480713130	480723130
	1500	480713230	480723230
	2000	480713330	480723330

All measurements are in mm.

n.a.: not available





## Non-driven pallet roller conveyors

For floor mounting.

Same specifications as for

driven conveyors but without gear motor and chains from roller to roller.

### Non-driven pallet conveyors

HEIGHT 90 MM

WIDTH	LENGTH	Rp 89 ITEM NO.	Rp 178 ITEM NO.
970	1000	480731131	480731132
	1500	480731231	480731232
	2000	480731331	480731332
1170	1000	480732131	480732132
	1500	480732231	480732232
	2000	480732331	480732332
1370	1000	480733131	480733132
	1500	480733231	480733232
	2000	480733331	480733332

All measurements are in mm.

## Driven 2-parted pallet roller conveyors

For driven conveyor connection.

The 2-parted roller conveyors make it possible to lead pallets from a roller conveyor in position for collection by hand lift truck.

Available with right or left side mounted gear motor and with or without capacitive sensor at pick-up end.

Same general specifications as for driven conveyors.



### Driven 2-parted pallet conveyors

HEIGHT 90 MM

WIDTH	LENGTH	Rp 89 ITEM NO.	Rp 178 ITEM NO.
970	1500	480741611	480741621
1170	1500	480742611	480742621
1370	1500	480743611	480743621

For left side mounted motor change 7th digit from "6" to "7".  
All measurements are in mm.

## Non-driven 2-parted pallet roller conveyors

The 2-parted roller conveyors make it possible to lead pallets from a roller conveyor in position for collection by hand lift truck.

Same general specifications as for driven conveyors but without gear motor.

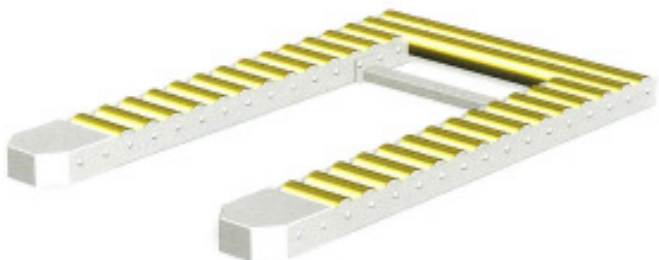

### Non-driven 2-parted pallet conveyors

HEIGHT 90 MM

WIDTH	LENGTH	Rp 89 ITEM NO.	Rp 178 ITEM NO.
970	1500	480751210	480751220
1170	1500	480752210	480752220
1370	1500	480753210	480753220

All measurements are in mm.

# Pallet roller conveyors – height 190



## Driven pallet roller conveyors

For support or floor mounting.

The max. length of a roller conveyor with one gear motor is 4.5 m with a max. payload of 1500 kg.

All sections are supplied with coupling fittings. Accessories pages 12-15.

### Specifications

**Frames:** Cold-bend angle profiles bolted to C-profile cross bars.

**Surface treatment:** Electro galvanized steel with the exception of gear motor, chain, and roller axles. Rollers are electro galvanized with yellow cromating.

**Rollers:** Ø 80 mm electro galvanized steel tubes.

**Axle diameter:** Ø 17 mm.

**Bearings:** 6203 – 2rs.

**Roller fittings:** Rollers suspended between side frames by means of M10 axle.

**Payload:** Max. 1500 kg per conveyor and per gear motor.

**Standard heights:** The total height from floor to top of rollers is 190 mm.

**Chain drive for rollers:** Chains operate beneath roller surface. Chain drive is from roller to roller. 1/2" sprockets of hardened steel are integrated with the bearing of the roller.

## Driven pallet conveyors

HEIGHT 190 MM EXCL. SUPPORTS. SIDE MOUNTED MOTOR

WIDTH	LENGTH	Rp 89 ITEM NO.	Rp 178 ITEM NO.
970	500	485911141	n.a.
	750	485911241	n.a.
	1000	480711141	480721141
	1500	480711241	480721241
	2000	480711341	480721341
1170	500	485912141	n.a.
	750	485912241	n.a.
	1000	480712141	480722141
	1500	480712241	480722241
	2000	480712341	480722341
1370	500	485913141	n.a.
	750	485913241	n.a.
	1000	480713141	480723141
	1500	480713241	480723241
	2000	480713341	480723341

All measurements are in mm.

n.a.: not available

**Chain cover:** Chains are protected by a u-profile mounted above the chains. The chain cover is beneath roller height to ensure access to pallets from both sides of the conveyor.

**Speed:** 11.4 m/min (other speeds available).

**Gear motor:** 0.37 kW. Worm reduction gear sidemounted on conveyor frame.



## Driven pallet roller conveyors

With submounted gear motor.

For support mounting only.

Except from the total height, it has the same specifications as driven conveyors with sidemounted gear motor.

## Driven pallet conveyors

HEIGHT 190 MINIMUM HEIGHT 255 MM EXCL. SUPPORTS. SUB MOUNTED MOTOR

WIDTH	LENGTH	Rp 89 ITEM NO.	Rp 178 ITEM NO.
970	500	485911121	n.a.
	750	485911221	n.a.
	1000	480711121	480721121
	1500	480711221	480721221
	2000	480711321	480721321
1170	500	485912121	n.a.
	750	485912221	n.a.
	1000	480712121	480722121
	1500	480712221	480722221
	2000	480712321	480722321
1370	500	485913121	n.a.
	750	485913221	n.a.
	1000	480713121	480723121
	1500	480713221	480723221
	2000	480713321	480723321

All measurements are in mm.

n.a.: not available



## Coupled sections for driven pallet roller conveyors

For support or floor mounting.

Same specifications as for driven conveyors but without gear motor.

### Coupled section for driven pallet conveyors

HEIGHT 190 MM EXCL. SUPPORTS

WIDTH	LENGTH	RP 89 ITEM NO.	RP 178 ITEM NO.
970	250	485911020	n.a.
	500	485911120	n.a.
	750	485911220	n.a.
	1000	480711120	480721120
	1500	480711220	480721220
	2000	480711320	480721320
1170	250	485912020	n.a.
	500	485912120	n.a.
	750	485912220	n.a.
	1000	480712120	480722120
	1500	480712220	480722220
	2000	480712320	480722320
1370	250	485913020	n.a.
	500	485913120	n.a.
	750	485913220	n.a.
	1000	480713120	480723120
	1500	480713220	480723220
	2000	480713320	480723320

All measurements are in mm.

n.a.: not available

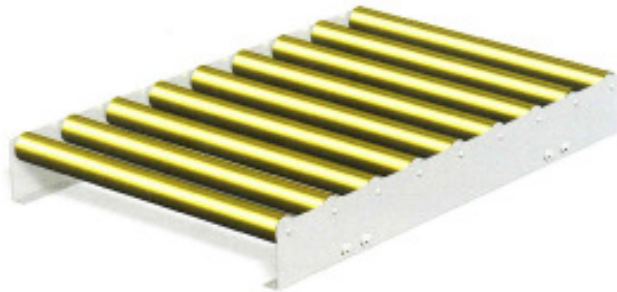

## Non-driven pallet roller conveyors

For support or floor mounting.

Same specifications as for driven conveyors but without gear motor and chains from roller to roller.

### Non-driven pallet conveyors

HEIGHT 190 MM EXCL. SUPPORTS

WIDTH	LENGTH	RP 89 ITEM NO.	RP 178 ITEM NO.
970	1000	480731121	480731122
	1500	480731221	480731222
	2000	480731321	480731322
1170	1000	480732121	480732122
	1500	480732221	480732222
	2000	480732321	480732322
1370	1000	480733121	480733122
	1500	480733221	480733222
	2000	480733321	480733322

All measurements are in mm.



Driven pallet conveyor system at Dansk Kaffe Kompagni in Denmark.

# Accessories for pallet roller conveyors



Adjustable  $\pm 15$  mm

## Supports for external mounting

HEIGHT	ITEM NO.
250	442731250
350	442731350
500	442731500

Other heights available on request. All measurements are in mm.

## Supports

Different models make it possible to achieve the desired operational height.

Supports for **external** mounting offer high durability and stability and are also recommended for heavy-duty purposes.

Supports for **internal** mounting are recommended where space does not allow external mounting. Supports for internal mounting are not recommended for heights exceeding 350 mm.



## Supports for internal mounting

HEIGHT	ITEM NO.
250	442732250
350	442732350

Other heights available on request. All measurements are in mm.



## Cross bars for supports

COMPULSORY FOR HEIGHTS EXCEEDING 350 MM  
USE 1 UNIT FOR 2 SUPPORTS

WIDTH	ITEM NO.
970	487750970
1170	487751170
1370	487751370

All measurements are in mm.



Driven pallet conveyor system at Coloplast in Denmark.



## Guide rail support

ONE UNIT

ITEM NO.	465141000
----------	-----------



## Guide rail

ITEM NO.	1303306000
----------	------------

State length in mm on the order.

## Side guides

To guide the pallets.

To order as complete side supports:

- State the required number of guide rail support units.
- State the required guide rail length in mm.

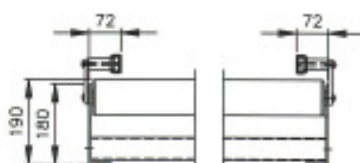

## Centre guides

For empty pallets of different sizes.

Are recommended to guide the centre part of the base of the pallet during the advancing.

Two guide rail supports are required for each unit of guide rail.

**Note:** Can be installed on pallet roller conveyors with RP 178 mm only.

### Guide rail support

ONE UNIT

ITEM NO. 465140210



### Guide rail

ITEM NO. 1303306000

State length in mm on the order.

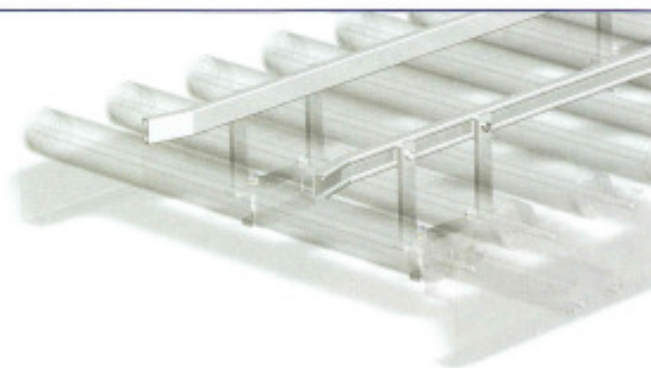

## Pallet end stop

Prevent pallets from exceeding the conveyor.

Universal model for all heights.

### Pallet end stop

FOR CONVEYOR HEIGHTS 90 MM OR 190 MM

WIDTH	ITEM NO.
970	481330970
1170	481331170
1370	481331370

All measurements are in mm.



## Sensor plate for driven conveyor

The sensor plate is used for communication to control system. This replaces an externally mounted photocell. A photocell is exposed to moisture, dirt, and impact. The sensor plate can be installed in both RP 89 and RP 178.

### Sensor plate for driven conveyor

FOR CONVEYOR HEIGHTS 90 MM OR 190 MM

WIDTH	ITEM NO.
970	323180970
1170	323181170
1370	323181370

All measurements are in mm.



## Guiding wheel

Available for RP 178 only.

### Guiding wheel

INCLUDING SUPPORT

ITEM NO. 464060000





## Pneumatic pallet stop

ONE UNIT COMPLETE  
WITH FITTINGS

WIDTH	ITEM NO.
970	213930811
1170	213931011
1370	213931211

All measurements in mm.



## Pneumatic pallet stop

Recommended for precise stopping of empty pallets. The benefit is that it aids pallet alignment i.e. for correct positioning for palletising.

**Minimum conveyor height:**  
190 mm.



## Brake roller

ONE UNIT COMPLETE  
WITH FITTINGS

WIDTH	ITEM NO.
970	483850970
1170	483851170
1370	483851370

All measurements in mm.



## Brake roller

To be used with non-driven conveyors to reduce gravity speed.



## Photocell fixtures

ONE UNIT COMPLETE  
WITH PHOTOCELL AND FITTINGS

Item no.	318077110
----------	-----------



## Photocell fixtures

For mounting of photocells and reflectors on roller conveyors and chain conveyors.



Rotary tables at Dansk Kaffe Kompagni in Denmark.

## Fork lift guard

Prevents fork lift damage to conveyor.

Used at all areas where pallet pick-up is made. The height of the fork lift guard is recommended to be 25 mm above roller height.

Can be side- or end mounted.



### Fork lift guard

THE RECOMMENDED 25 MM IS INCLUDED

CONVEYOR WIDTH	HEIGHT 250 ITEM NO.	HEIGHT 350 ITEM NO.	HEIGHT 500 ITEM NO.
970	309941250	309941305	309941500
1170	309942250	309942305	309942500
1370	309943250	309943305	309943500

Other heights available on request.  
All measurements in mm.

## Fork lift stop

Prevents a fork lift from driving into the conveyor.

### Fork lift stop

WIDTH	ITEM NO.
970	On request
1170	On request
1370	On request

All measurements in mm.



## Support rollers

Used for supporting pallet transfer from a rotary table or stretch wrapper onto a pallet roller conveyor.

This type is applicable for RP 178 mm only.

Supports need to be ordered separately. One set per conveyor consists of a right and a left unit.

### Supports

ONE SET  
(LEFT + RIGHT)

HEIGHT	ITEM NO.
250	483420250
350	483420350
470	483420470

Other heights available on request.  
All measurements in mm.

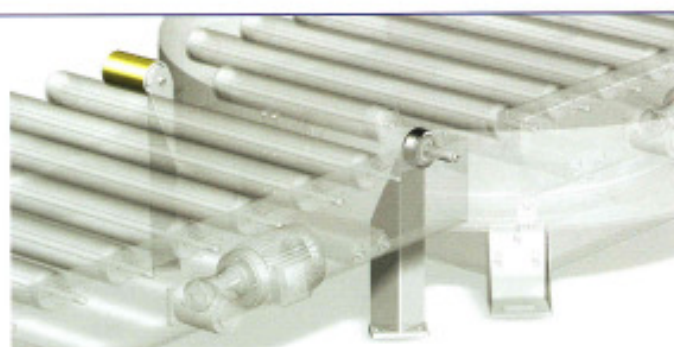

### Rollers

DRIVEN SIDE

ROLLER WIDTH	ITEM NO.
35 mm	482610119



### Rollers

NON-DRIVEN SIDE

ROLLER WIDTH	ITEM NO.
118 mm	306000118





### Chain conveyors simplex chain

HEIGHT 225 MM EXCL.  
SUPPORTS

WIDTH	LENGTH	ITEM NO.
750	1000	462851145
	1500	462851245
	2000	462851345
	2500	462851545
	3000	462851445
950	1000	462852145
	1500	462852245
	2000	462852345
	2500	462854545
	3000	462852445

All measurements in mm.

### Driven chain conveyors simplex chain

Chain conveyors are designed for pallets and other goods with a plane, solid base.

Chain conveyors are suitable for pallet accumulation.

Width 750 mm is designed for 800 mm x 1200 mm pallets, travelling with either side leading.

Width 950 mm is designed for 1000 mm x 1200 mm and 1200 mm x 1200 mm pallets

travelling with either side leading.

For heavy-loaded pallets, a conveyor with 3 chains is recommended. Please ask for further information.

#### Specifications

**Chains:** 3/4" pallet chain with straight side plates.

**Chain distance:**  
cc 700 mm for width 750.  
cc 900 mm for width 950.

**Payload:** Max. 1500 kg per conveyor and per motor.

**Standard height:**  
Supports available for standard heights from 225 mm to 650 mm – other heights on request.

**Gear motor:** 0.55 kW.  
Worm reduction gear mounted on crossbar between the frames.

**Speed:** 11.4 m per minute, 1500 kg with one gear motor. Other speeds available on request.

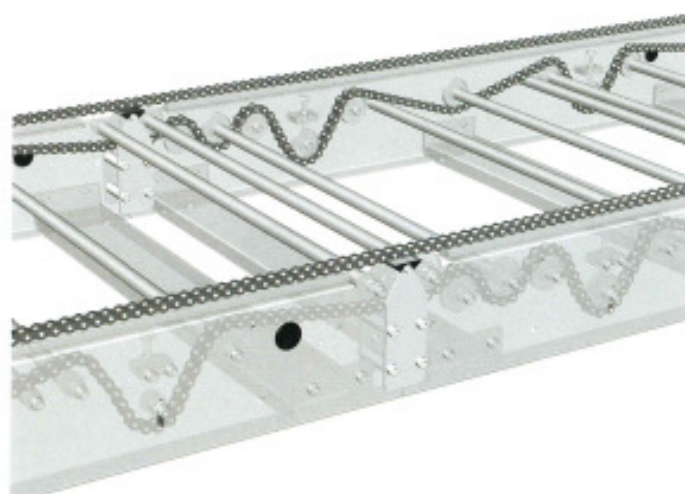

### Coupled sections simplex chain

HEIGHT 225 MM EXCL.  
SUPPORTS

WIDTH	LENGTH	ITEM NO.
750	1000	462851100
	1500	462851200
	2000	462851300
	2500	462851500
	3000	462851400
950	1000	462852100
	1500	462852200
	2000	462852300
	2500	462852500
	3000	462852400

All measurements in mm.

### Coupled sections

It is recommended to install supporting blocks between coupled sections.

Please see page 20.

Same specifications as for driven chain conveyor but without gear and motor.



### Driven chain conveyors duplex chain

Conveyor width 290 mm is designed for  $\frac{1}{2}$  and  $\frac{1}{4}$  pallets depending on base configuration.

Same specifications for chain, gear motor, and speed as for driven conveyors simplex chain.

#### Driven chain conveyors duplex chain

HEIGHT 225 MM EXCL. SUPPORTS

WIDTH	LENGTH	ITEM NO.
290	1000	485950155
	1500	485950255
	2000	485950355
	2500	485950455
	3000	485950555

All measurements in mm.

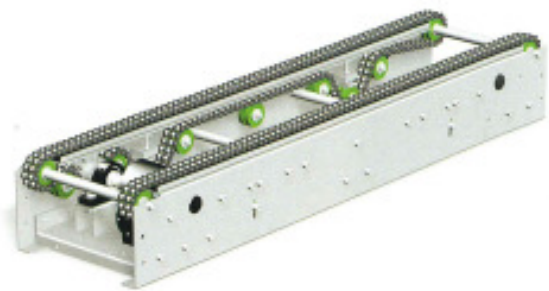

### Double driven chain conveyors simplex chain

Designed for EUR  $\frac{1}{2}$  and  $\frac{1}{4}$  pallets in wood or plastic depending on base configuration.

Same specifications for chain, gear motor, and speed as for driven conveyors simplex chain.

#### Double driven chain conveyors simplex chain

HEIGHT 225 MM EXCL. SUPPORTS

WIDTH	LENGTH	ITEM NO.
750	1000	476251155
	1500	476251255
	2000	476251355
	2500	476251455
	3000	476251555

All measurements in mm.

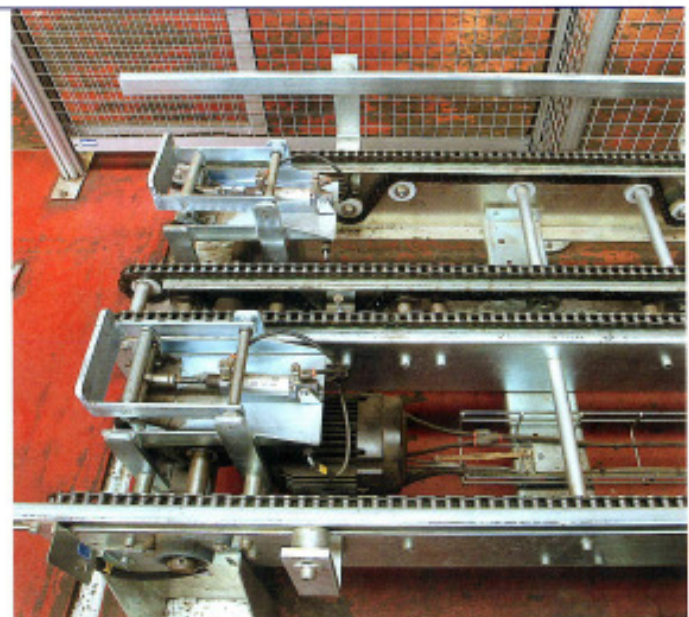
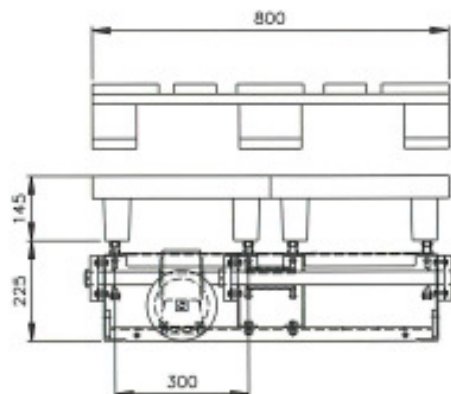

Chain conveyor system for  $\frac{1}{4}$  plastic pallets. The system is equipped with pneumatic stops for precise positioning of pallets at Dansk Kaffe Kompagni in Denmark.



### Supports for external mounting

HEIGHT	ITEM NO.
250	442740250
350	442740350
500	442740500

Other heights available on request.  
All measurements in mm.

### Supports for chain conveyors

Different models and heights make it possible to achieve the optimum operation height.

Supports for **external** mounting offer high durability and stability and are also recommended for heavy-duty purposes.

Supports for **internal** mounting are recommended where space does not allow external mounting. Supports for internal mounting are not recommended for heights exceeding 350 mm.

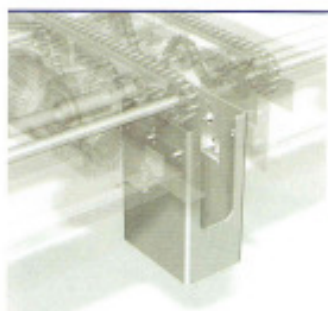

### Supports for internal mounting

HEIGHT	ITEM NO.
250	442742250
350	442742350
500	442742500

Other heights available on request.  
All measurements in mm.

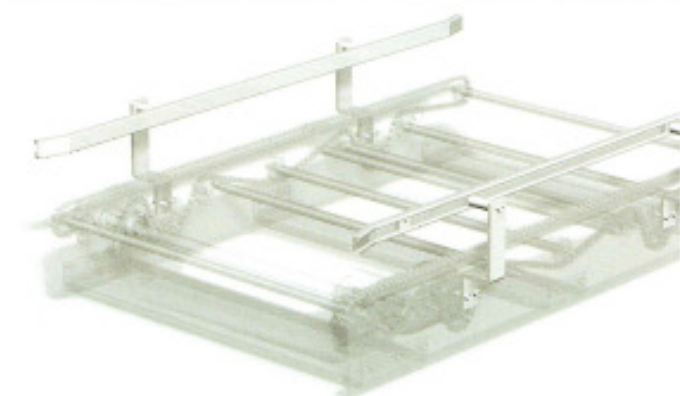

### Side guides

SIDE SUPPORTS INCLUDING GUIDE RAIL FOR TWO SIDES

LENGTH	ITEM NO.
1000	486111000
1500	486111500
2000	486112000

All measurements in mm.

### Side guides

To guide pallet movement.

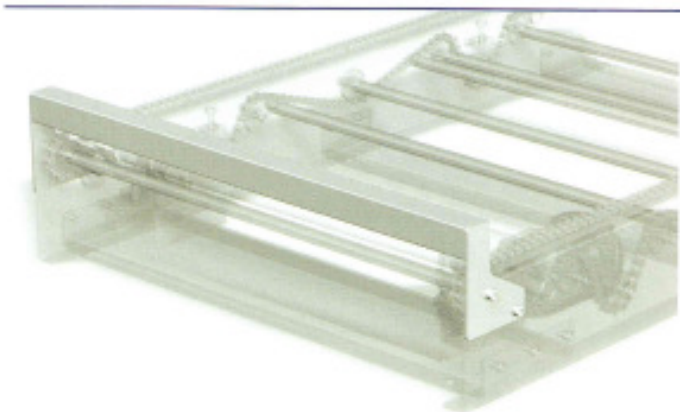

### Pallet end stop

WIDTH	ITEM NO.
290	315970360
750	315970750
950	315970950

All measurements in mm.

### Pallet end stop

Prevents pallets from exceeding the chain conveyor.



## Capacitive sensors

For signal exchange to control system.

Capacitive sensors can replace a photocell which is exposed to moisture, dirt and impacts.

### Capacitive sensors

ONE SET

ITEM NO. 468340000

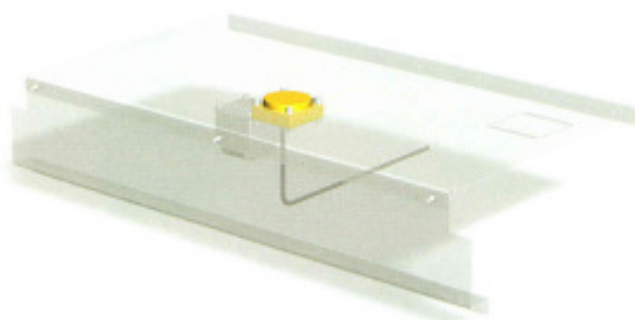

## Photocell fixtures

For mounting of photocells and reflectors on roller conveyors and chain conveyors.

### Photocell fixtures

ONE UNIT COMPLETE WITH PHOTOCELL AND FITTINGS

ITEM NO. 318077110

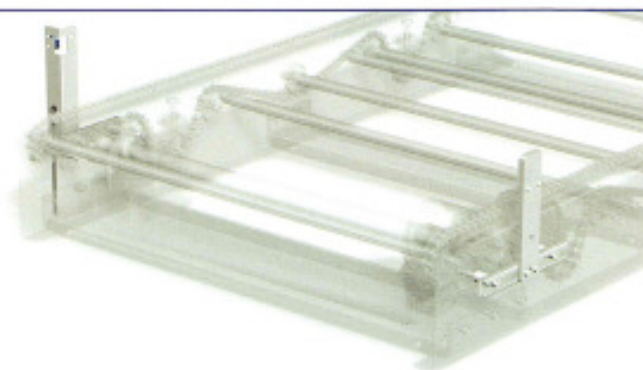

## Fork lift stop

Prevents fork lift damage to conveyor.

Can be used at all areas where pallet pick-up is undertaken.

### Fork lift stop

WIDTH	ITEM NO.
290	On request
750	On request
950	On request

All measurements in mm.



## Pneumatic pallet stop

For all pallet widths.

### Pneumatic pallet stop

FOR STANDARD PALLETS

ITEM NO. 486023602



## Pneumatic pallet stop

For 1/4 pallets.

### Pneumatic pallet stop

FOR 1/4 PALLETS

ITEM NO. 484000814

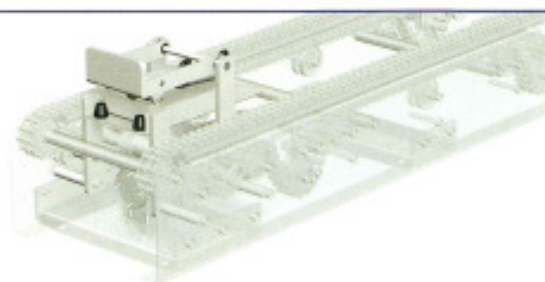

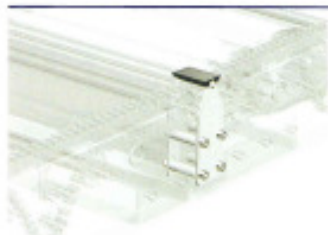

## Supporting block

ITEM NO. 474490000

## Supporting block

Fixed between conveyors to support transition of pallets between conveyors.



## Supporting block

	ITEM NO.
Right	474490021
Left	474490022

## Supporting block

Fixed on conveyor end to support transition of pallets.

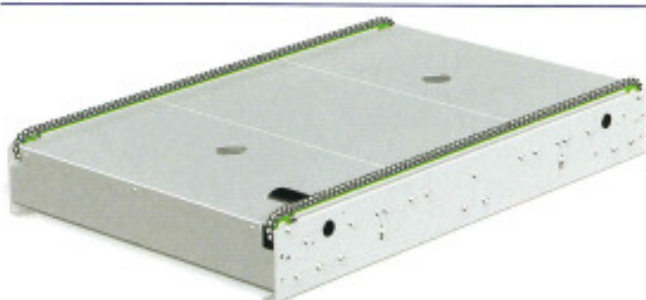

## Top cover plates for simplex chain conveyors

Prevent dirt from entering between chains and facilitate passing on the conveyor. Top cover plates are available for all SOCO SYSTEM chain conveyor models.

### Order example

Conveyor of length 2000 mm and width 750 mm:

1 unit	315780011
3 units	315780021
2 units	315770020



## Top cover plates for motor end of conveyor

LENGTH 500 MM  
PREPARED FOR CAPACITIVE SENSOR  
Ø 80 MM

WIDTH	ITEM NO.
290	319101011
750	315780010
950	315780011

All measurements in mm.



## Other top cover plates

LENGTH 500 MM

WIDTH	ITEM NO.
290	319101020
750	315780020
950	315780021

All measurements in mm.



## End cover plates

WIDTH	ITEM NO.
290	319081010
750	315770010
950	315770020

All measurements in mm.

## Top cover plates for duplex model

Prevent dirt from entering between chains and facilitate passing on the conveyor.

### Order example

Conveyor of length 2500 mm and width 290 mm:

1 unit 319101010

4 units 319101020

2 units 319081010



### Top cover plates for motor end of conveyor

LENGTH 500 MM

WIDTH	ITEM NO.
290	319101010

All measurements in mm

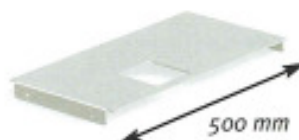

### Other top cover plates

LENGTH 500 MM

WIDTH	ITEM NO.
290	319101020

All measurements in mm

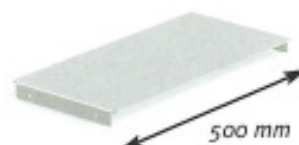

### End cover plates

WIDTH	ITEM NO.
290	319081010

All measurements in mm



Simplex chain conveyor system at Dansk Kaffe Kompagni, Denmark.

# Pallet rotary tables



## Rotary tables

The rotary table is used to change the direction of travel of pallets.

Fitted with roller conveyor – also available with chain conveyor on request. The turntable can rotate  $\pm 90^\circ$  and  $\pm 180^\circ$ .

## Specifications

### Standard height:

350 mm or 470 mm. Standard minimum height 310 mm. Other heights on request.

### Payload:

Max. 1500 kg.

### Rotation:

2.8 or 3.75 RPM.

### Gear motor:

0.25 kW.

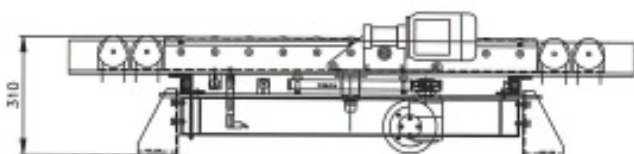

Rotary table with conveyor of height 90 mm.

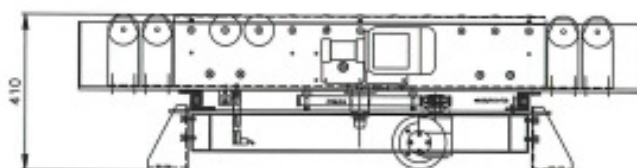

Rotary table with conveyor of height 190 mm.

## Three step order process:



Pallet conveyor height 190 mm.

### 1. Top part: Pallet conveyor with skirt

CONVEYOR WIDTH	HEIGHT 90 MM		HEIGHT 190 MM	
	RP 89 ITEM NO.	RP 178 ITEM NO.	RP 89 ITEM NO.	RP 178 ITEM NO.
970	482711111	482721111	482711121	482721121
1170	482712111	482722111	482712121	482722121
1370	482713111	482723111	482713121	482723121

All measurements in mm.

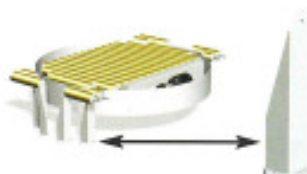

### Console for support rollers

ITEM NO. 483420xxx\*

xxx\* insert conveyor height in mm.

External support rollers are included to ensure smooth transition of pallets to and from the rotary table.

Consoles for support rollers must be ordered separately.

Please order consoles in required height. Support roller consoles are not height adjustable.

### 2. Middle part: Rotary table base with base structure

CONVEYOR WIDTH	BASE PLATE DIAMETER	ITEM NO.
970	1480	483391105
1170	1630	483392105
1370	1780	483393105

All measurements in mm.





### 3. Base part: Supports

OPERATING HEIGHT	PALLET CONVEYOR HEIGHT	SUPPORT HEIGHT	ITEM NO.
90 mm	190 mm		
350 mm	470 mm	260 mm	442733260

Adjustable  $\pm 20$  mm.  
Other heights on request.

### Rotary tables with safety cover

Version for operation outside safety zone.

Rotary table equipped with protection plates that covers top and side.

For further information, contact SOCO SYSTEM.



Close-up of top and side plates.

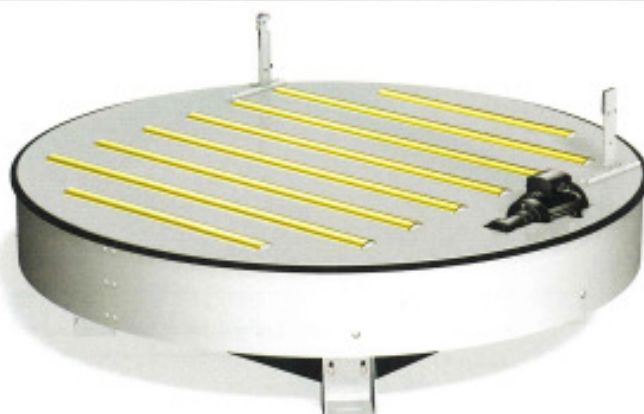

### Pallet transfer units

The transfer unit makes a 90° change of direction of pallet movement.

The 90° transfer unit is a chain conveyor which is raised and lowered automatically above roller height.

Can be fitted in all pallet conveyors where the height exceeds 350 mm.

#### Specifications

**Motors:** Two motors – one for up/down movement and one for chain movement.

**Chains:** 3/4" pallet chain with straight side plates.

**Chain distance:** 700 mm.

**Standard widths:** 970 mm, 1170 mm, and 1370 mm.

**Standard height:** 350 mm.

**Payload:** Max. 1500 kg per pallet.

**Transferspeed:** 11.4 m/min. (other speeds available).

#### Gear motor:

Chain conveyor 0.55 kW.  
Lifting unit 0.37 kW.

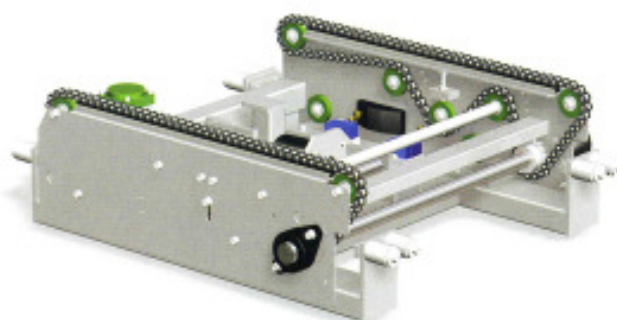

### Pallet transfer units

CONVEYOR WIDTH	ITEM NO. MOTOR RIGHT SIDE MOUNTED	ITEM NO. MOTOR LEFT SIDE MOUNTED
970	471221731	471221732
1170	471222731	471222732
1370	471223731	471222733

All measurements are in mm.

# Pallet transfer trolleys

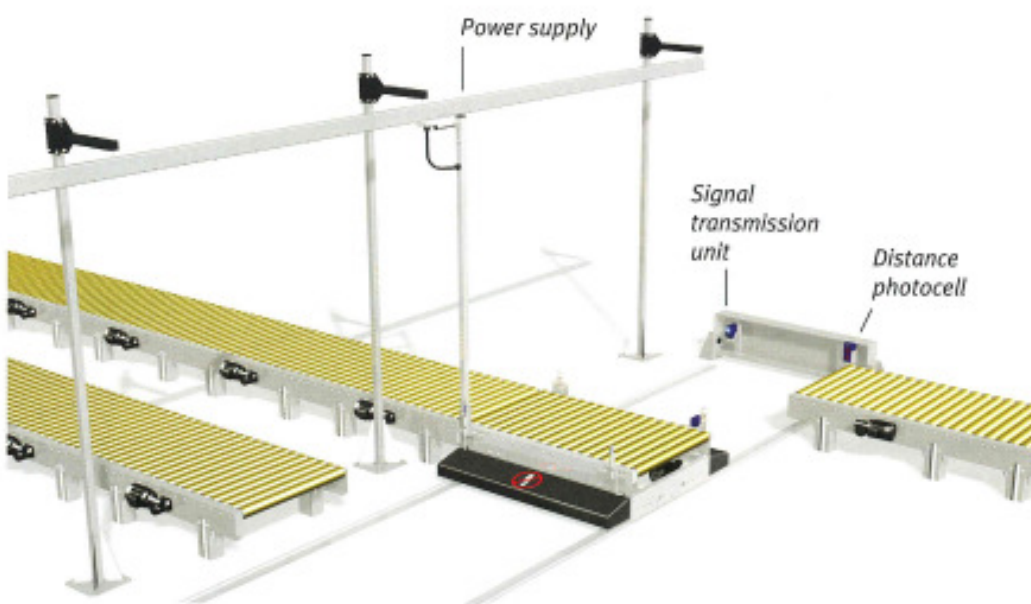
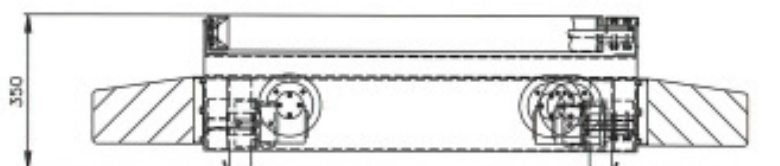

## Pallet transfer trolleys

Suitable for transport of pallets between two or more conveyor lines.

One of several applications is to deliver empty pallets from a single pallet magazine to several pallet loaders and to collect full pallets and transfer these for onward central conveying.

The transfer trolley can be fitted with:

- Driven roller conveyors.
- Chain conveyors.
- Rotary table with roller or chain conveyor.
- 90° angled transfer unit.

The standard transfer trolley has safety bumpers. On contact, the transfer trolley stops. The transfer trolley runs on rails fitted into or on the floor.

### Specifications

**Standard width:** 970 mm, 1170 mm, and 1370 mm.

**Standard length:** 1500 mm.

**Minimum operating height:**

With roller conveyor:

350 mm.

With chain conveyor:

450 mm.

Other heights on request.

**Payload:** Max. 1500 kg.

**Speed:** Standard 10 m/min.

Other speeds available on request.

**Gear motor:** 2 units each of 0.25 kW.

**In connection with an order, please send the following information to SOCO SYSTEM:**

- Products to be transferred
- Pallet sizes and direction of movement
- Pallet load height
- Desired operating height – minimum and standard is 350 mm
- Distance of trolley movement
- Required capacity in number of pallet transfers per hour
- Preferred method of power supply "overhead rail" or floor mounted "energy chain"
- Preferred method of floor rail – "built in" or "rails on floor"
- Preferred method of personnel protection



## Pallet exchangers

The pallet exchanger consists of 2 side modules which are bolted to the floor.

The pallet fingers on the modules hold the pallet at approximately 240 mm above the floor.

No pneumatic air or electricity is required.

Pallet exchangers can be used for all pallet sizes.

**Payload:** Max. 500 kg.

**Capacity:** 15 pallets.

### Pallet exchangers

ADJUSTABLE FOR ALL PALLET SIZES

ITEM NO. 477270000

*By changing the distance between the two side modules, the pallet exchanger is easily adapted for the actual pallet size. The modules are then bolted to the floor.*

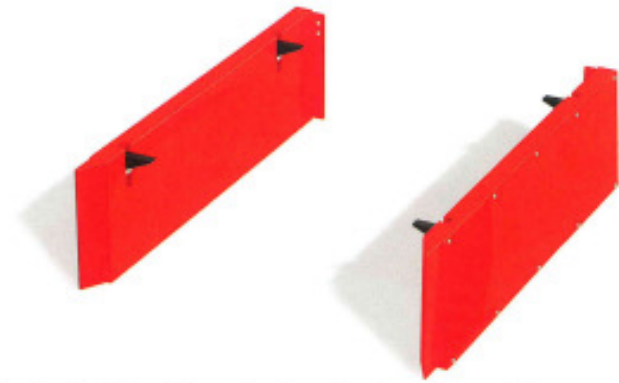

### Simple and quick pallet change at the packing station

With the pallet exchanger, the exchange of pallets at the packing station becomes a rational operation. There is no more need for unpractical and time consuming stops and no need for space to put pallets into waiting position.



### Easy and safe pallet stacking

The pallet stacker makes stacking of pallets a simple and safe operation. Empty pallets are inserted from below and lifted. This gives tall and straight pallet stacks that can be removed in one move.



*Transfer trolley installed in a pallet roller conveyor system supplied to Organon, Ireland.*

# Pallet magazines



## PalManager A versatile pallet magazine

Pallets can be stacked/  
destacked individually or as  
stacks.

The magazine can be  
operated manually or  
function automatically.

Using photocells and  
built-in automatic control  
system, the PalManager  
determines if stacking or  
destacking is required.  
The PalManager is used either  
as a single module or as an  
integrated part of a system.



**PALMANAGER MULTI  
FOR 14 PALLETS**

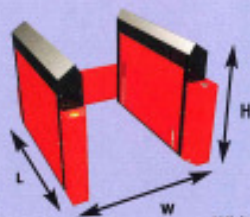

Width for Multi Versions:  
Pallet width 800 = 1190 mm  
Pallet width 1000 = 1390 mm  
Pallet width 1200 = 1590 mm Other dimensions, see table

**PALMANAGER 4Way MULTI  
FOR 14 PALLETS**

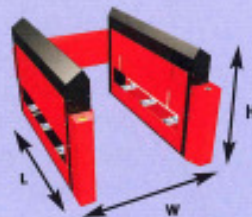

**PALMANAGER AND  
PALMANAGER 4Way FOR  
24/24/20 PALLETS**

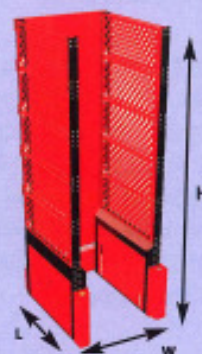

ITEM NO.	MODEL	PALLET SIZE IN MM	MAX. NO. OF PALLETS	MAX. KG	AIR AND POWER SUPPLY	DIMENSIONS IN MM L X W X H
<b>PALMANAGER MULTI FOR 14 PALLETS</b>						
455200041	PalManager Multi 800/1000/1200	1200 X 800-1200	14	500	Compressed air 6-10 bar, 8 l/ cycle, power supply: 1 X 230 volt	1375 X varia. X 980
<b>PALMANAGER FOR 24/24/20 PALLETS</b>						
455200081	PalManager 800	1200 X 800	24	1000	Compressed air 6-10 bar, 16 l/ cycle, power supply: 1 X 230 volt	1375 X 1190 X 3550
455200082	PalManager 1000	1200 X 1000	24	1000	Compressed air 6-10 bar, 16 l/ cycle, power supply: 1 X 230 volt	1375 X 1390 X 3550
455200083	PalManager 1200	1200 X 1200	20	1000	Compressed air 6-10 bar, 16 l/ cycle, power supply: 1 X 230 volt	1375 X 1590 X 3550
<b>PALMANAGER 4Way MULTI FOR 14 PALLETS</b>						
455200091	PalManager 4Way Multi 800/1000/1200	1200 X 800-1200	14	500	Compressed air 6-10 bar, 8 l/ cycle, power supply: 1 X 230 volt	1675 X varia. X 980
<b>PALMANAGER 4Way FOR 24/24/20 PALLETS</b>						
455200101	PalManager 4Way 800	1200 X 800	24	1000	Compressed air 6-10 bar, 16 l/ cycle, power supply: 1 X 230 volt	1675 X 1190 X 3550
455200102	PalManager 4Way 1000	1200 X 1000	24	1000	Compressed air 6-10 bar, 16 l/ cycle, power supply: 1 X 230 volt	1675 X 1390 X 3550
455200103	PalManager 4Way 1200	1200 X 1200	20	1000	Compressed air 6-10 bar, 16 l/ cycle, power supply: 1 X 230 volt	1675 X 1590 X 3550

The PalManager is available in two models:

### PalManager

Pallets to/from floor and conveyor systems.

### PalManager 4Way

Pallets to/from conveyor systems in all 4 directions.

The Multi versions for 14 pallets have an adjustable rear section for different pallet widths.

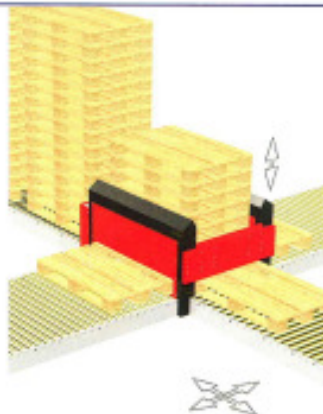

*PalManager 4Way. The PalManager is easy to integrate into fully automatic lines.*

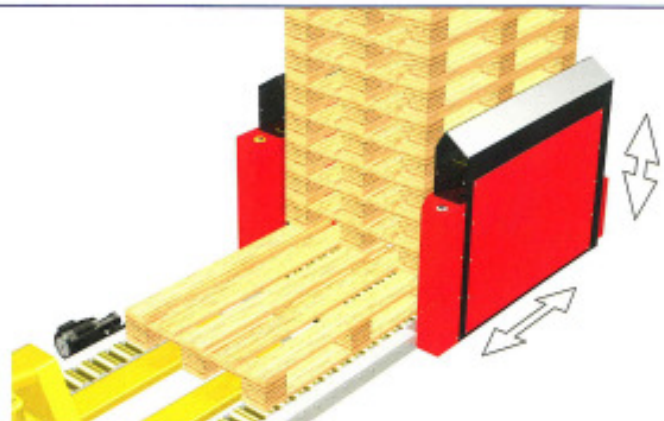

*This Multi version stacks/destacks the pallets from pallet roller conveyors of heights as low as 90 mm. Here shown with 2-parted infeed/outfeed conveyor.*

## Pallet magazine for heavy-duty use

This model is used where heavy-duty palletising systems are required.

The pallet magazine can be filled by forklift with stacks or single pallets.

The magazine can handle different sizes of pallets. Change-over time less than one minute.

### Specifications

**Payload:** Max. 500 kg.

**Operating height:**  
Min. 235 mm.

**Air and power supply:**  
Compressed air 6-10 bar,  
8 l/cycle, power supply:  
1 x 230 volt.

Can also be supplied with separate electrical control cabinet.

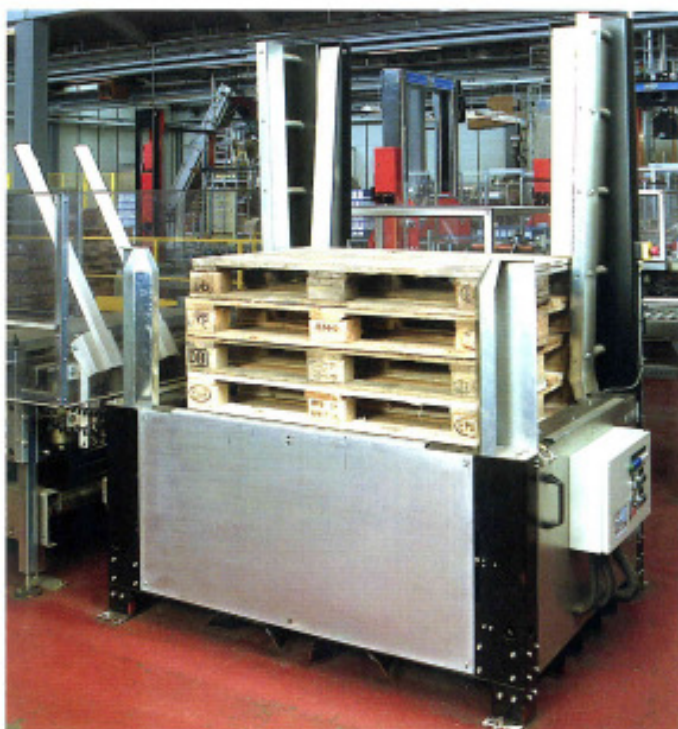

*Pallet magazine at Dansk Kaffe Kompagni in Copenhagen.*

**In connection with an order, please send the following information to H+D**

- Pallets to be handled (type and size).
- "In" and "out" direction of movement.

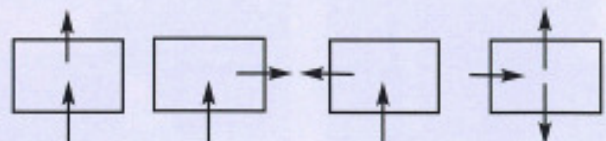

- Method of replenishment – by forklift or pallet stacker.
- Required operating height (minimum 235 mm with forklift and minimum 350mm with pallet stacker).

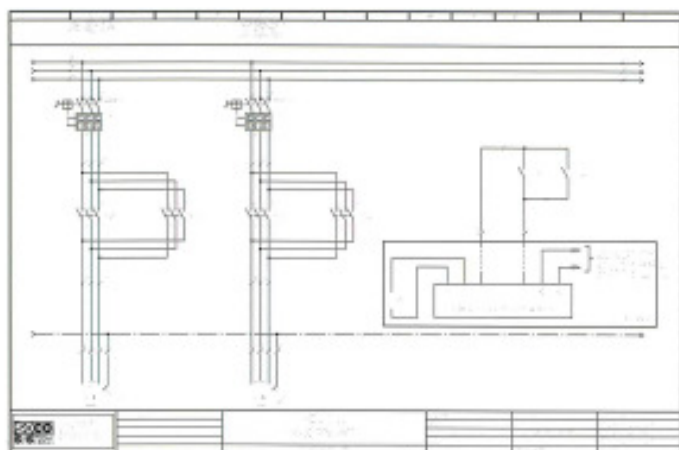

Clear electrical diagrams detail the programme setup.

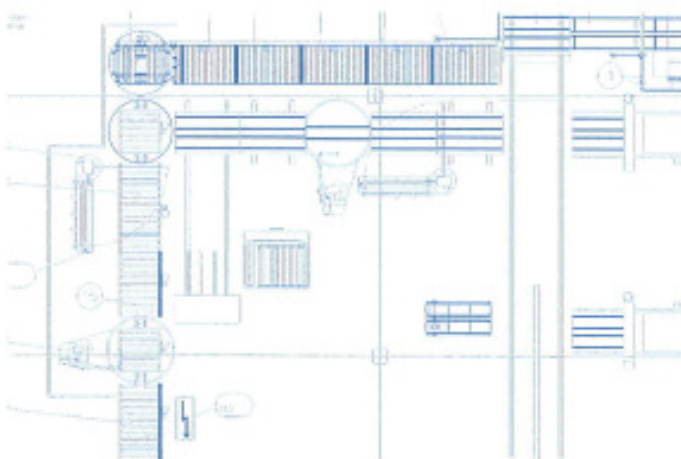

Full system layout is provided with each installation.



Customised control panels with touch screen features for easy man/machine interaction.



Photocell monitoring.



Well organised control cabinets with space for expansion.

## Control systems

SOCO SYSTEM supplies customised control systems for end-of-line packing and handling systems.

Our control systems are based on PLC programme platforms such as Siemens, Omron, Allen – Bradley. Customer specifications and customer choice of control systems and electrical components can be met.

## Palletising equipment

Systems including palletising robots are supplied as standard with an IPC equipped with a Soft-PLC. This supports in full the IEC 1131 standard.

Overall operating system platform and man/machine interface is Windows based.

The IPC controlling the palletising robot can also control virtually all peripheral equipment. Production data can be provided for overall control systems. Programmes can be changed through modem access, and error messages can be sent by e-mail or SMS.

## Operator interface

SOCO SYSTEM's user interfaces are designed to facilitate the operation of the system, with well-defined error messages to ensure simple trouble-shooting procedures.

It can be designed for different levels of access to ensure maximum machine security and personnel safety.

Operator interface systems are a very important feature in the smooth operation of integrated end-of-line systems. SOCO SYSTEM has proven experience in developing efficient operator interfaces.

Contact our project department for further information

## Safety guidelines

SOCO SYSTEM modules are manufactured to meet CE requirements and specifications.

Each module is secured individually in the best possible way. Combinations of modules, however, may require further safety and security measures to prevent accidents and to increase personnel safety.

SOCO SYSTEM offers an individual safety and personnel security evaluation as well as recommend solution. Such solutions can include fencing, light curtains, automatic gates, safety curtains, and doors operated and controlled automatically. This ensures that the complete installation meets the requirements in the EEC directives.

The solutions offered are tailor-made to meet your specific requirements and to suit your premises.

SOCO SYSTEM integrates the most recent industrial security systems from reputable European suppliers.

SOCO SYSTEM equipment meets the following EC directives:

73/23 EEC – 89/336 EEC  
– 98/37 EC

and thereby also the following harmonised standards:

EN 291-X – EN 418 – EN 954  
– EN 959 – EN 999 – EN 1050  
– EN 60204-1.



*Customised fencing for pallet conveyor line with integrated fully automatic pallet stretch wrapper.*



*Automatic light curtain protection preventing entry to the danger zone but allowing exit of a full pallet.*

## General specifications

### Electrical specifications

SOCO SYSTEM equipment meets the electrical specification requirements of EC and the USA. Please request electrical specification details for further information.

### Materials

SOCO SYSTEM equipment is manufactured in first class steel plates.

### Surface treatment

SOCO SYSTEM products are supplied in electro galvanised steel or powder coated in standard colours.

Other colours are available on request.

Where special surfaces of steel plates or specific requirements for access to cleaning are requested these can be supplied – ask for information.

### Stainless steel

Stainless steel versions are available on request. SOCO SYSTEM can supply different types of stainless steel versions depending on requirement.

### Environment

SOCO SYSTEM pallet handling equipment is designed for use:

- In rooms with temperatures ranging from +5°C to +45°C.
- In rooms with a relative humidity of no more than 50% at 40°C or 90% at 20°C.

For cold store use in rooms from +5°C to -35°C, SOCO SYSTEM can supply standard equipment in special versions – please ask for further information.

For use in aggressive environment, SOCO SYSTEM can supply standard equipment in special versions – please ask for further information.

### Safety

Pallet roller conveyors with RP 178 mm with operating height below 600 mm and chain conveyors need to be fenced to meet EC regulations for personnel safety. Pallet roller conveyors with RP 89 mm with any operating height does not need to be fenced (See page 29).

## Pallet roller conveyors

**Frames:** Cold-bend angle profiles bolted to C-profile cross bars.

### Surface treatment

Electro galvanized steel with the exception of gear motor, chain, and roller axles. Rollers have increased wear properties and are electro galvanized with yellow chromating.

### Rollers

Ø 80 mm electro galvanized steel tubes.

### Axle diameter

Ø 17 mm.

### Bearings

6203 – 2RS.

### Roller fittings

Rollers suspended between side frames by means of Ø 17 mm axle.

### Payload

Max. 1500 kg per conveyor and per gear motor.

### Standard height

Height from floor to top of rollers from 90 mm.

### Chain drive for rollers

Chains operate beneath roller surface. Chain drive is from roller to roller. 1/2" sprockets are integrated with the bearing of the roller. The sprockets are made of hardened steel to ensure increased wear properties. The bearing unit is fixed to

the roller by 4 subsurface pressure points.

### Chain cover

Chains are protected by a U-profile mounted above the chains. The chain cover is beneath roller height to ensure access to pallets from both sides of the conveyor.

### Gear motor

0.37 kW. Worm reduction gear fixed to conveyor frame.

### Speed

11.4 m/min (other speeds available).

### Roller pitch

RP – the distance between the roller centres.



*Rollers are equipped with through-going 17 mm steel axles fitted at both ends into 6203 2RS steel ball bearings, lubricated for life. Chains from roller to roller ensure a smooth and efficient transmission of power. Stainless steel bearings are available on request.*

## Chain conveyors

### Chains

3/4" pallet chain with straight side plates.

### Payload

Max. 1500 kg per conveyor and per motor.

### Standard height

Total height from floor to top of chain from 225 mm.

### Gear motor

0.55 kW. Worm reduction gear fixed to conveyor frame.

### Cover plates

Cover plates can be supplied to protect the interior of the chain conveyor. Often used to prevent dirt from entering and to improve visual appearance.

### Surface treatment

Electro galvanized steel with the exception of gear motor, chain, and axles.

### Speed

11.4 m/min:  
1500 kg (with one gear).

## Ausstellung

Auf 400 m<sup>2</sup> Ausstellungsfläche erleben Sie Ideen modernster Verpackungstechnologie – zum Anschauen, Anfassen und Testen. Besuchen Sie uns in Immenstadt!



## Packmuseum

So wurde früher verpackt. Ein Blick in Deutschlands erstes Packmuseum bei H+D.





VERPACKEN MIT SYSTEM

**Hagenauer + Denk KG**

Illerstraße 8

87509 Immenstadt-Seifen

Telefon (08323) 9660-0

Telefax (08323) 9660-70

Internet: [www.hagenauer-denk.de](http://www.hagenauer-denk.de)

[www.verpacken.de](http://www.verpacken.de)

E-mail: [info@hagenauer-denk.de](mailto:info@hagenauer-denk.de)